

Clarke®

Start··charge



12V & 24V 80A INTELLIGENT BATTERY CHARGER

MODEL NO: IBC80

PART NO: 6267019

OPERATION & MAINTENANCE INSTRUCTIONS

UK
CA | CE



ORIGINAL INSTRUCTIONS

DL0921

INTRODUCTION

Thank you for purchasing this CLARKE Battery Charger.

Before use, read this manual thoroughly and follow all instructions given.

1. The IBC80 is designed for charging all types of 12V & 24V lead-acid including WET (Flooded), MF (Maintenance-Free), EFB (Enhanced Flooded Battery), GEL, AGM (Absorbed Glass Mat) batteries.
2. A built-in intelligent microprocessor makes charging faster, easier and safer.
3. This charger has safety features, including protection for reverse polarity, short circuit, overheat and overcharge.

GUARANTEE

This CLARKE product is guaranteed against faulty manufacture for a period of 12 months from the date of purchase. Please keep your receipt as proof of purchase.

This guarantee is invalid if the product is found to have been abused or tampered with in any way, or not used for the purpose for which it was intended.

Faulty goods should be returned to their place of purchase, no product can be returned to us without prior permission.

This guarantee does not effect your statutory rights.

ENVIRONMENTAL RECYCLING POLICY



Through purchase of this product, the customer is taking on the obligation to deal with the WEEE in accordance with the WEEE regulations in relation to the treatment, recycling & recovery and environmentally sound disposal of the WEEE.

In effect, this means that this product must not be disposed of with general household waste. It must be disposed of according to the laws governing Waste Electrical and Electronic Equipment (WEEE) at a recognised disposal facility.

OVERVIEW

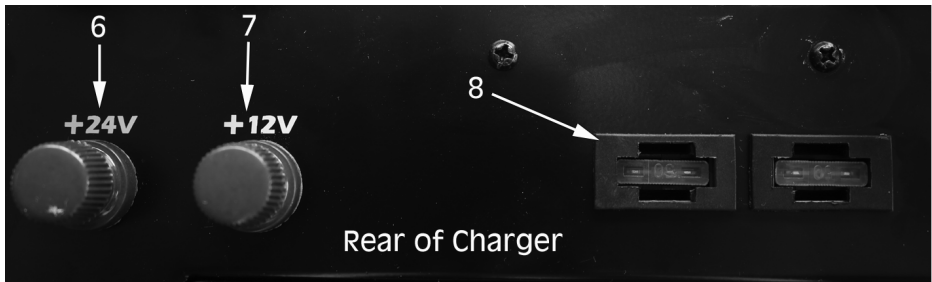

1	Negative (Black) Lead	5	Cable Rack
2	Positive (Red) Lead	6	Screw Clamp for Positive Lead for Charging 24V Batteries
3	Display & Control Panel	7	Screw Clamp for Positive Lead for Charging 12V Batteries
4	Handle	8	2 x 50A Fuses

SPECIFICATIONS

Model Number	IBC80
Input Voltage	230V AC, 50Hz,
Battery Charging Voltages	12V DC & 24V DC
Battery Types	WET (Flooded), MF (Maintenance-Free), EFB (Enhanced Flooded Battery), GEL (Gelified Electrolyte), AGM (Absorbed Glass Mat)
Output Currents	5A/10A/20A 80A Start Mode
Boost Duty Cycle	5 Seconds On, 180 Seconds Off
IP Rating	IP20
Min./Max. Charging Battery Size	4Ah - 350Ah
Charging Steps	10 Steps (Intel. Charger - Maintainer)
Operating Temperature Range	0°C to 40°C
Dimensions (D x W x H)	270mm x 250mm x 160mm
Weight	9 kg
Charging Lead Length (red& black)	1.90 m
Mains Power Cable Length	1.76 m

	Max. Input Power	Max. Input Current	Output (Charging/ Starting)	Charging Voltage
Charge-12V-20A	390W	2.2A	20A	12V
12V-Start(6V)	1034W	5A	60A	6V
12V-Start(3V)	1350W	6.5A	85A	3V
Charge-24V-20A	695W	4.3A	20A	24V
24V-Start(6V)	2620W	12.5A	75A	10V
24V-Start(3V)	2744W	13.4A	80A	8V

SAFETY INSTRUCTIONS



WARNING: WEAR EYE PROTECTION, HAND AND CLOTHING PROTECTION. AVOID TOUCHING EYES WHILE WORKING WITH A BATTERY. SEE YOUR LOCAL CLARKE DEALER FOR ALL YOUR PPE REQUIREMENTS.

SAFETY PRECAUTIONS FOR WORKING IN THE VICINITY OF A BATTERY

1. This charger **SHOULD NOT** be used to charge Lithium-Ion batteries.
2. Wear complete eye, hand and clothing protection. Avoid touching eyes while working near a battery.
3. Clean the battery terminals before they are connected to the charger. Be careful to keep corrosion from coming into contact with your eyes.
4. If battery electrolyte contacts skin or clothing, wash immediately with soap and water. If electrolyte enters your eye, immediately flood the eye with running clean cold water for at least 15 minutes and get medical attention immediately.
5. Batteries generate explosive gases during normal operation. Use in a well-ventilated area.
6. Consider having someone close enough or within the range of your voice to come to your aid when you work near a battery.
7. **DO NOT** smoke, strike a match or cause a spark in vicinity of a battery or engine. Avoid explosive gas, flames and sparks.
8. Remove all rings, bracelets, necklaces and watches while working with a vehicle battery. These items may produce a short-circuit that could cause severe burns.
9. Be extra cautious to reduce risk of dropping a metal tool onto the battery. It might spark or short-circuit a battery or other electrical hardware which may cause an explosion or fire.
10. Study all battery manufacturer's specific precautions such as removing or not removing cell caps while charging and recommended rates of charge.
11. When it is necessary to remove a battery from a vehicle to charge it, always remove the grounded terminal from the battery first. Make sure all accessories in the vehicle are off in order to prevent an arc.
12. It is **NOT** intended to supply power to an extra-low-voltage electrical system or to charge dry-cell batteries. Charging dry-cell batteries may burst and cause injury to persons and property.

13. **NEVER** charge a frozen, damaged, leaking or non-rechargeable battery.

SAFETY PRECAUTIONS FOR USING THE CHARGER









WARNING: ALWAYS SWITCH OFF THE CHARGER WHEN CONNECTING OR DISCONNECTING LEADS.

1. **DO NOT** cover the charger while charging.
2. **DO NOT** expose to rain or wet conditions.
3. Use of an attachment not recommended or sold by the manufacturer may result in a risk of fire, electric shock or injury to persons.
4. **DO NOT** overcharge batteries by selecting the wrong charge mode.
5. To reduce the risk of damage to the electric plug and lead, pull by the plug rather than the lead when disconnecting the charger.
6. Operate with caution if the charger has received a impact/blow or been dropped. Have it checked and repaired if damaged.
7. Any repair must be carried out by the manufacturer or an authorized CLARKE repair agent in order to avoid danger.

CHARGER LOCATION

1. **NEVER** place the charger in the engine compartment or near moving parts or near the battery; place as far away from them as the clamp leads allow.
2. **DO NOT** position the charger above the battery during the charging procedure. Gases from the battery will corrode and damage the charger.
3. **DO NOT** let battery acid drip on the charger when reading a hydrometer for specific gravity or when you fill the battery.
4. **DO NOT** use the charger in an enclosed space with reduced airflow.

SAFETY SYMBOLS

	Wear Eye Protection		Wear Protective Clothing
	Wear Protective Gloves		WEEE Directive
	Indoor Use Only		Warning: Risk of Electrical Shock
	Warning: Battery Charging		

ELECTRICAL CONNECTIONS



WARNING! READ THESE ELECTRICAL SAFETY INSTRUCTIONS THOROUGHLY BEFORE CONNECTING THE PRODUCT TO THE MAINS SUPPLY.

Before switching the product on, make sure that the voltage of your electricity supply is the same as that indicated on the rating plate. This product is designed to operate on 230VAC 50Hz. Connecting it to any other power source may cause damage.

This product may be fitted with a non-rewireable plug. If it is necessary to change the fuse in the plug, the fuse cover must be refitted. If the fuse cover becomes lost or damaged, the plug must not be used until a suitable replacement is obtained.

If the plug has to be changed because it is not suitable for your socket, or due to damage, it should be cut off and a replacement fitted, following the wiring instructions shown below. The old plug must be disposed of safely, as insertion into a mains socket could cause an electrical hazard.

If the colours of the wires in the power cable of this product do not correspond with the markings on the terminals of your plug, proceed as follows.

- The Blue wire must be connected to the terminal marked N or coloured Black.
- The Brown wire must be connected to the terminal marked L or coloured Red.
- The Yellow and Green wire must be connected to the terminal marked E or  or coloured Green.

Plug must be BS1363/A approved.

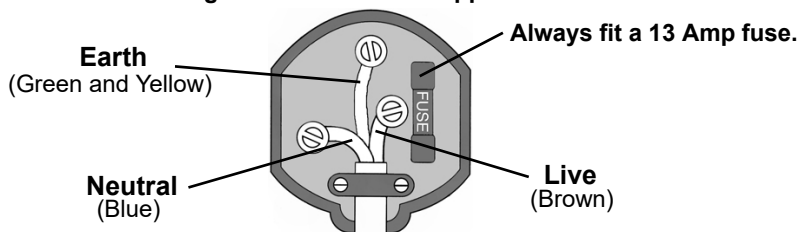

Ensure that the outer sheath of the cable is firmly held by the clamp

We strongly recommend that this machine is connected to the mains supply via a Residual Current Device (RCD). If in any doubt, consult a qualified electrician. DO NOT attempt any repairs yourself.

THE CHARGING PROCESS

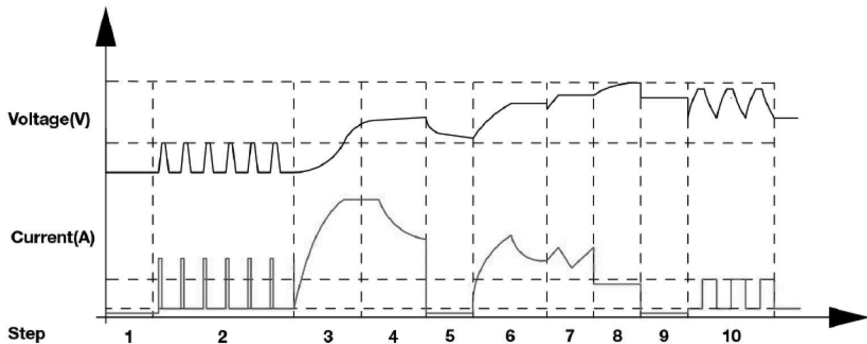

STEP 1: ANALYSING 1: Checks if the battery has connected with the charger.

STEP 2: DESULPHATION: If battery voltage is too low, the program automatically generates a pulsing current to remove sulphate.

STEP 3: SOFT START: Charges with gradually increasing charging current.

STEP 4: CONTROLLED CURRENT CHARGE: Adjusts the charging current intelligently.

STEP 5: ANALYSING 2: Tests if the battery can absorb charge.

STEP 6: CONSTANT OUTPUT CHARGE: Charges with constant voltage and compensates for any fake full charge caused by high current charging.

STEP 7: RECOVERY CYCLE CHARGE: Absorbs more charge and compensates for the side effect of reduced charging current.

STEP 8: ABSORPTION: Charges with constant trickle current for maximum battery voltage.

STEP 9: ANALYSING 3: Tests if the battery can hold charge.

STEP 10: MAINTENANCE: Continuously monitors the battery, and charges with trickle current once the voltage is lower than threshold.

CONNECTING TO THE BATTERY

1. Identify the voltage of the battery to be charged, 12V or 24V. Connect the Positive (Red) lead to the appropriate screw clamp on the rear of the charger.
2. Identify the polarity of battery posts. The positive battery terminal is typically marked by these letters or symbol (POS,P,+). The negative battery terminal is typically marked by these letters or symbol (NEG,N,-).
3. **DO NOT** make any connections to the carburetor, fuel lines, or thin metal parts.
4. Identify if you have a negative or positive grounded vehicle. This can be done by identifying which battery post (NEG or POS) is connected to the chassis.
 - **FOR A NEGATIVE GROUNDED VEHICLE (MOST COMMON):** connect the RED POSITIVE clamp first to the positive battery terminal, then connect the BLACK NEGATIVE clamp to the negative battery terminal or vehicle chassis.
 - **FOR A POSITIVE GROUNDED VEHICLE (VERY UNCOMMON):** connect the BLACK NEGATIVE clamp first to the negative battery terminal, then connect the RED POSITIVE clamp to the positive battery terminal or vehicle chassis.
5. When disconnecting, disconnect in the reverse sequence, removing the negative first (or positive first for positive ground systems).



CAUTION: A MARINE (BOAT) BATTERY MUST BE REMOVED AND CHARGED ON SHORE. TO CHARGE IT ON BOARD REQUIRES EQUIPMENT SPECIALLY DESIGNED FOR MARINE USE.

OPERATION

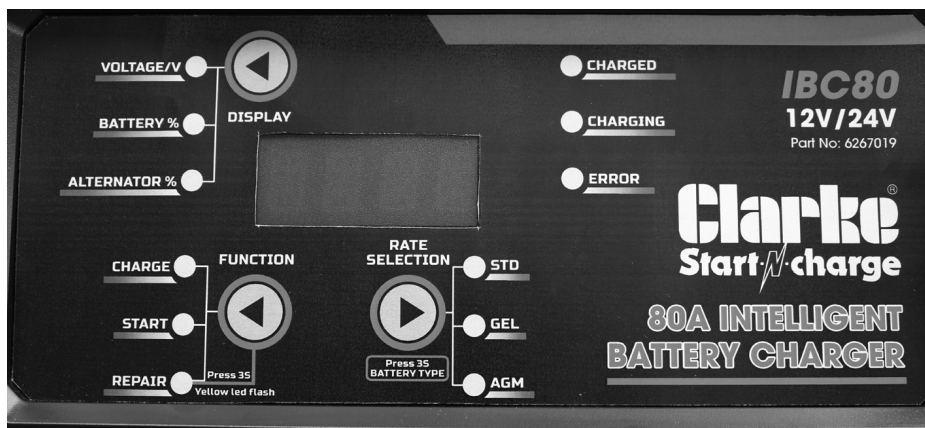

DISPLAY BUTTON

Press the **DISPLAY** button until the following LED is lit:

1. **VOLTAGE/V** - When the charger is **NOT** charging a battery, the display will show the battery voltage.
2. **BATTERY%** - When in charging, the digital display shows an estimated charge percentage of the battery connected to the chargers battery clamps.
3. **ALTERNATOR%** - The digital display shows an estimated output percentage of the vehicles charging system connected to the chargers battery clamps, compared to a properly functioning system.

FUNCTION BUTTON

1. **CHARGE** - Press & hold the **RATE SELECTION** button for 3 seconds to choose battery type (STD/GEL/AGM) first, and press & hold the same button for 3 seconds until the digital display shows **OFF**. Then press the **RATE SELECTION** button once to choose the charging current. After that, press the **FUNCTION** button until the **CHARGING** LED is lit to enter this mode (digital display shows **CHARGE-ON**). When in charging, the battery type cannot be changed. To stop charging, press the **FUNCTION** button again and **CHARGE** LED will be off (digital display shows **CHARGE-OFF**).
2. **START** - Your battery charger can be used to jump start your car if the battery is low. Follow all safety instructions and precautions for charging

your battery. Wear complete eye protection and protective clothing. The procedures are as follows:



WARNING: USING THE ENGINE START FEATURE WITHOUT A BATTERY INSTALLED IN THE VEHICLE WILL DAMAGE THE VEHICLE'S ELECTRICAL SYSTEM.

- Connect the charger to the battery following the instructions given on page 10.
- With the charger plugged in and connected to the battery and chassis, press the **FUNCTION** button until the **START** LED is lit.
- Turn on the vehicles ignition until the vehicle starts or 3 seconds has passed. If the engine does not start, wait 4 minutes before trying again. This allows the charger and battery to cool down.
- If the engine fails to start, use the **CHARGE** maximum rate (10A) to charge for some minutes before attempting to start the engine again.
- After the engine starts, unplug the AC power cord before disconnecting the battery clamps from the vehicle.

NOTE: If the engine turns over but never starts, there is not a problem with the starting system; there is a problem somewhere else with the vehicle. STOP all ignition attempts until the other problem has been diagnosed and corrected.

During the starting sequence listed above, the charger is set to one of three states:

While waiting for ignition, the digital display shows:

- **START-READY** - The charger waits until the engine is actually being started before delivering the amps for the engine start.
 - **CRANKING** - When ignition is detected, the charger will automatically deliver up to its maximum output as required by the starting system for up to 10 seconds.
 - **COOL DOWN** - After ignition, the charger enters a mandatory 180 seconds cool down state (Pressing any button **DOES NOT** work). The digital display indicates the remaining cool down time in seconds. It starts at 180 and counts down to 0. After 3 minutes, the digital display will change from displaying the countdown to displaying **START-READY**.
3. **REPAIR** - Press & hold the **FUNCTION** button for 3 seconds until the **REPAIR** LED is lit to enter this mode (digital display shows **REPAIR-ON**). It is an advanced battery recovery mode for repairing old, idle, stratified or sulfated batteries. **NOT** all batteries can be recovered. For optimal results, take the battery through a full charge cycle, bringing the battery to full

charge before using this mode. This mode uses a high charging voltage and may cause some water loss in WET cell batteries. Plus, some batteries and electronics may be sensitive to high charging voltages. To minimise risks, disconnect the battery from the vehicle before using this mode. To stop repairing, press the **FUNCTION** button again and **REPAIR** LED will go off (digital display shows **REPAIR-OFF**).

ALTERNATOR CHECK

Before the charger is connected with the battery which should be well seated in the vehicle, press the **DISPLAY** button until the **ALTERNATOR%** LED is lit, start the vehicle and turn the vehicles headlights on. The alternator percentage range is from 0% to 100%. Readings below 0% will read **LO** and readings above 100% will read **HI**. If you get a **HI** or **LO** reading, have the electrical system checked by a qualified technician.

CHARGING TIME DURATION

Different battery capacity, residual voltage and charging current will all affect charging time. The following table is for guidance in the case of a fully discharged battery.

Battery Size - Ah	Approx. Time to Charge					
	12V			24V		
	5A	10A	20A	5A	10A	20A
10	2.5h	1.5h	33mins	2.5h	1.5h	55mins
20	4h	2.5h	1.5h	4h	2.5h	1.5h
40	5h	5h	2.5h	5h	5h	2.5h
80	17h	9h	5h	17h	9h	5h
100	33h	17h	9h	33h	17h	9h
350	71h	36h	18.5h	71h	36h	18.5h

CARE & MAINTENANCE

This battery charger requires minimal maintenance. As with any appliance or tool, a few common sense rules will prolong its working life.



WARNING: ALWAYS BE SURE THE CHARGER IS UNPLUGGED BEFORE PERFORMING ANY MAINTENANCE OR CLEANING. ANY REPAIRS MUST BE DONE BY A QUALIFIED CLARKE SERVICE TECHNICIAN.

-
1. Wind up the leads when not in use. Examine the leads at regular intervals for damage and have them replaced if necessary.
 - Clean the case and leads if necessary with a moist cloth and clean any corrosion from the clamps with a solution of water and baking soda.

ERROR MESSAGES

1. E01 Display + **ERROR LED** lit: Reverse connection
2. E02 Display + **ERROR LED** lit: Temperature in charger is too high
3. E03 Display + **ERROR LED** lit: The battery cannot store electric charge (dead battery)
4. E04 Display + **ERROR LED** lit: No battery connected/battery voltage is lower than 1 volt (dead battery)
5. **REPAIR-ON** displayed + **REPAIR LED** flashing: Charger automatically enters repairing mode
6. **REPAIR-ON** displayed + **REPAIR LED** solid lit: Manually choose repairing mode

TROUBLESHOOTING

Problem	Cause	Solution
Battery does not charge	Lack of AC input power.	Make sure that the charger is plugged into AC outlet and check 50A fuses on rear of the charger.
	Faulty connections to battery terminals.	Unplug the charger and check the battery connection. Ensure that there is a good connection at the battery terminal/post and/or vehicle chassis.
	Wrong charge voltage selection.	Check that the correct charge voltage was selected for the battery being charged.
	Battery voltage too low.	Ensure enough charging time was allowed to charge battery.
	Charging a very cold battery.	If the battery being charged is extremely cold (below freezing), it will not accept a high rate of charge, so the initial charging rate will be slow. The rate of charging will increase as the battery warms. NEVER attempt to charge a frozen battery.
Display not showing	Lack of AC input power.	Make sure that the charger is plugged into AC outlet and check 50A fuses on rear of the charger.
		Check AC plug fuse and replace if necessary

COMPONENT PARTS DIAGRAM

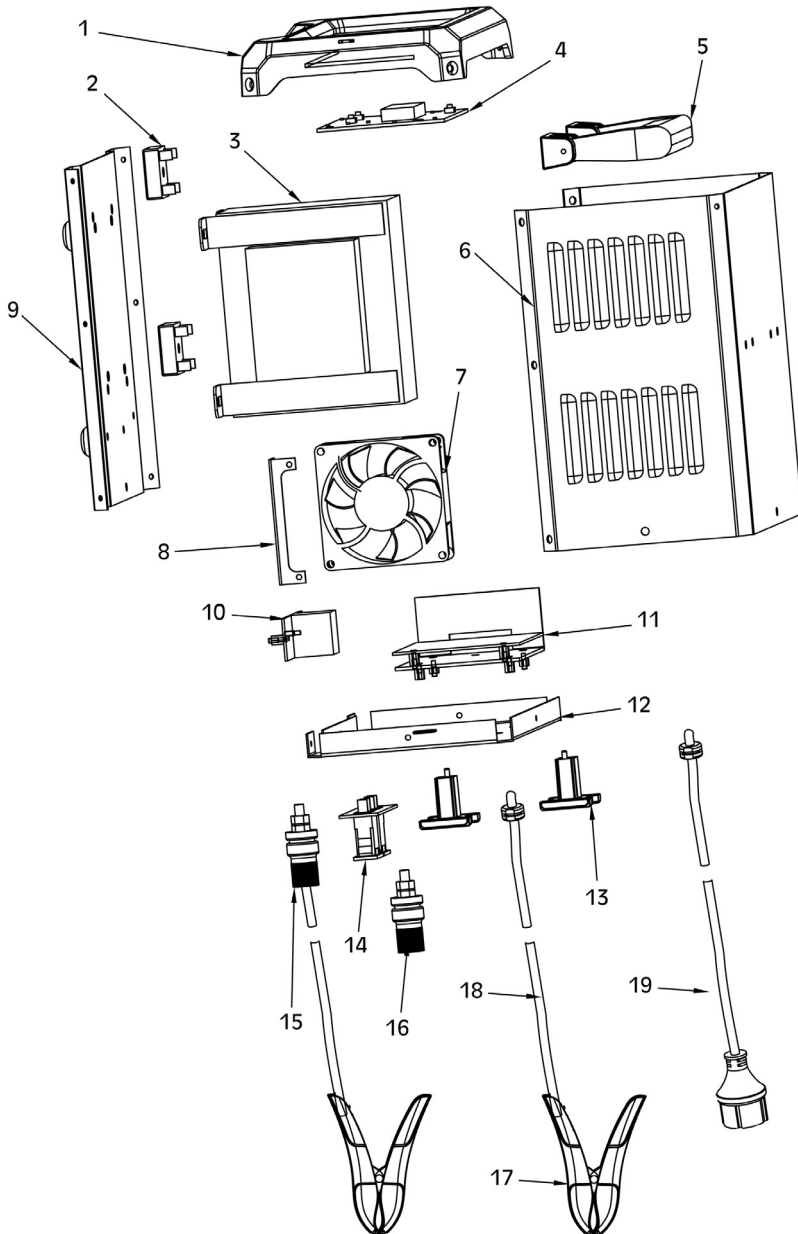

COMPONENT PARTS LIST

PART NO	DESCRIPTION	PART NO	DESCRIPTION
1	Front Cover	11	Main PCB - Radiator
2	Rectifier Bridge	12	Rear Cover
3	Transformer	13	Cable Rack
4	Control - PCB	14	Fuse
5	Handle	15	12VDC Positive Red Cable Joint
6	Exterior Metal Case	16	24VDC Positive Red Cable Joint
7	Fan	17	Clamps
8	Fan Holder	18	12/24VDC Negative Black Cable
9	Base Plate	19	AC Power Cable
10	Relay		

DECLARATION OF CONFORMITY - UKCA



Hemnoll Street, Epping, Essex CM16 4LG

DECLARATION OF CONFORMITY

This is an important document and should be retained.

We hereby declare that this product(s) complies with the following statutory requirement(s):

Electromagnetic Compatibility Regulations 2016

Electrical Equipment (Safety) Regulations 2016

The Restriction of the Use of Certain Hazardous Substances in Electrical and Electronic Equipment Regulations 2012

The following standards have been applied to the product(s):

EN 61000-6-1:2007, EN 61000-6-3:2007+A1:2011, EN 60335-2-29:2004+A2:2010,

EN 60335-1:2012 +A11:2014 + A13:2017, EN 62233:2008, IEC 62321-2:2013, IEC 62321-1:2013,

IEC 62321-3-1:2013, IEC 62321-5:2013, IEC 62321-7-1:2015, IEC 62321-7-2:2017,

IEC 62321-6:2015, IEC 62321-8:2017.

The technical documentation required to demonstrate that the product(s) meet(s) the requirement(s) of the aforementioned legislation has been compiled and is available for inspection by the relevant enforcement authorities.

The UKCA mark was first applied in: 2021

Product Description: 12/24V intelligent battery charger 80A
Model number(s): IBC80
Serial / batch Number: N/A
Date of Issue: 13/07/2021

Signed:

J.A. Clarke
Director

DECLARATION OF CONFORMITY - EU



Clarke[®]
INTERNATIONAL

Fitzwilliam Hall, Fitzwilliam Place, Dublin 2

DECLARATION OF CONFORMITY

This is an important document and should be retained.

We hereby declare that this product(s) complies with the following directive(s):

2014/30/EU *Electromagnetic Compatibility Directive.*
2014/35/EU *Low Voltage Equipment Directive.*
2011/65/EU *Restriction of Hazardous substances (Amendment EU 2015/863).*

The following standards have been applied to the product(s):

*EN 61000-6-1:2007, EN 61000-6-3:2007+A1:2011, EN 60335-2-29:2004+A2:2010,
EN 60335-1:2012 +A11:2014 + A13:2017, EN 62233:2008, IEC 62321-2:2013, IEC 62321-1:2013,
IEC 62321-3-1:2013, IEC 62321-5:2013, IEC 62321-7-1:2015, IEC 62321-7-2:2017,
IEC 62321-6:2015, IEC 62321-8:2017.*

The technical documentation required to demonstrate that the product(s) meet(s) the requirement(s) of the aforementioned directive(s) has been compiled and is available for inspection by the relevant enforcement authorities.

The CE mark was first applied in: 2021

Product Description: 12/24V intelligent battery charger 80A
Model number(s): IBC80
Serial / batch Number: N/A
Date of Issue: 13/07/2021

Signed:

J.A. Clarke
Director

A SELECTION FROM THE VAST RANGE OF

Clarke®

QUALITY PRODUCTS



AIR COMPRESSORS

From DIY to industrial, Plus air tools, spray guns and accessories.

GENERATORS

Prime duty or emergency standby for business, home and leisure.

POWER WASHERS

Hot and cold, electric and engine driven - we have what you need

WELDERS

Mig, Arc, Tig and Spot. From DIY to auto/industrial.

METALWORKING

Drills, grinders and saws for DIY and professional use.

WOODWORKING

Saws, sanders, lathes, mortisers and dust extraction.

HYDRAULICS

Cranes, body repair kits, transmission jacks for all types of workshop use.

WATER PUMPS

Submersible, electric and engine driven for DIY, agriculture and industry.

POWER TOOLS

Angle grinders, cordless drill sets, saws and sanders.

STARTERS/CHARGERS

All sizes for car and commercial use.

PARTS & SERVICE:

0208 988 7400

Parts Enquiries

Parts@clarkeinternational.com

Servicing & Technical Enquiries

Service@clarkeinternational.com

SALES: UK 01992 565333 or Export 00 44 (0)1992 565335

Clarke INTERNATIONAL Hemnall Street, Epping, Essex CM16 4LG
www.clarkeinternational.com